

# The Transformer

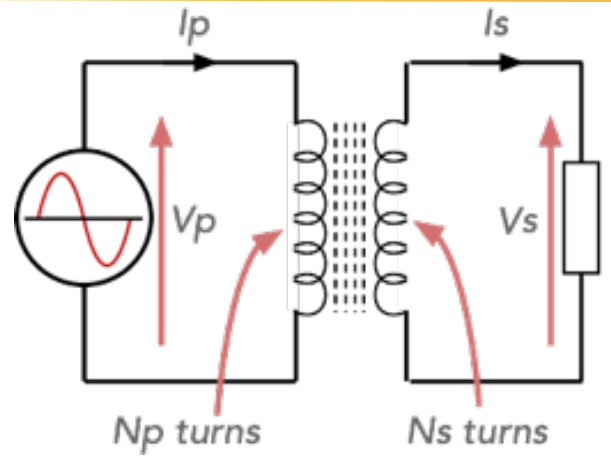

Typical mains transformer



$$V_s = V_p \frac{N_s}{N_p}$$

$$I_s = I_p \frac{N_p}{N_s}$$

## Circuit Symbols

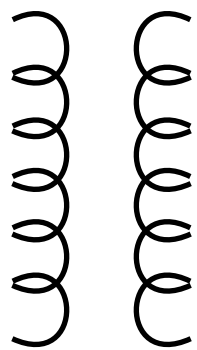

Air cored transformer

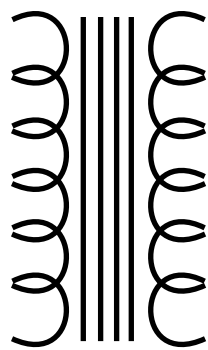

Iron / laminated cored transformer

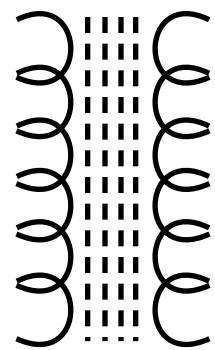

Ferrite cored transformer

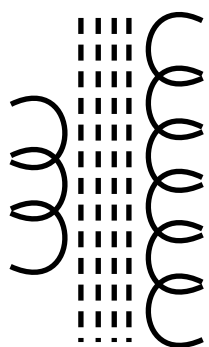

Step-up transformer

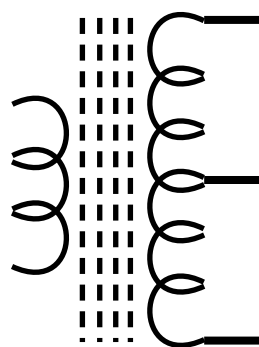

Centre-tapped transformer

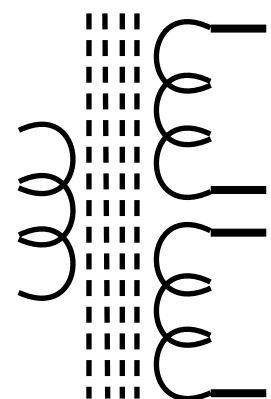

Dual secondary transformer